

Serie **DECO**

---

**aries**  
STAR MEDICAL SYSTEMS

# SerieDECO

Serie**DECO** nasce dall'esigenza espressa da molti professionisti di coniugare estetica e funzionalità. Soluzioni tecniche all'avanguardia sono combinate ai materiali più moderni. La struttura dei mobili è in lamiera di acciaio elettrozincata verniciata a polveri epossidiche. Serie**DECO** viene proposta in due varianti di design: Linea**D**, con i frontali in poliuretano e Linea**M** in lamiera elettrozincata con maniglia in alluminio.

Se l'armonia delle forme e la praticità sono le qualità che cercate, le troverete in Serie**DECO**.

Serie**DECO** arose from the need expressed by many professionals to find a successful mix of design and function. Cutting edge technological solutions are combined with the apex of modern materials. The unit frames are made of electro-galvanised steel with an epoxy powder coated paint finish. Serie**DECO** is offered in two design variations: Linea**D**, with polyurethane front panels and Linea**M** in galvanised steel and aluminium handles.

If you are looking for harmony of shape and practicality, you will definitely find these qualities in Serie**DECO**.

Née de l'exigence, exprimée par de nombreux professionnels, de marier esthétique et fonctionnalité, Serie**DECO** offre des solutions techniques d'avant-garde associées à des matériaux novateurs. La structure des meubles est en acier électro-zingué verni avec des poudres époxydiques. Serie**DECO** est proposée en deux modèles différents: la Linea**D**, avec des façades en polyuréthane et la Linea**M** en tôle électro-zinguée avec des poignées en aluminium. Si l'harmonie des formes et la commodité sont les qualités que vous recherchez, Serie**DECO** est faite pour vous.

Serie**DECO** entspringt dem von vielen Zahnärzten geäußerten Wunsch, Design und Funktionalität unter einen Hut zu bekommen. Zukunftsgerichtete technische Lösungen werden kombiniert mit modernsten Materialien. Die Struktur der Möbel besteht aus elektroverzinktem Stahlblech mit Epoxypulverbeschichtung. Serie**DECO** präsentiert sich in zwei Designausführungen: Linea**D** mit Fronten aus Polyurethan und Linea**M** aus elektroverzinktem Blech mit Aluminiumgriff.

Wenn Sie auf der Suche sind nach harmonischen Formen und Zweckmäßigkeit, dann wird Sie die Serie**DECO** überzeugen.

Serie**DECO** nace de la exigencia expresada por muchos profesionales de conjugar estética y funcionalidad. Soluciones técnicas a la vanguardia se combinan con los materiales más modernos. La estructura de los muebles está realizada con chapa de acero electrogalvanizada pintada con polvos epoxídicos. Serie**DECO** se propone en dos variantes de diseño: Linea**D**, con las partes frontales de poliuretano, y Linea**M**, de chapa electrogalvanizada con tirador de aluminio.

Si la armonía de las formas y la facilidad de utilización son las cualidades que busca, las encontrará en Serie**DECO**.



linea **D**



linea **M**



Serie**DECO** offre la migliore componentistica come ad esempio i cassetti ad estrazione totale con rientro ammortizzato.  
In foto: mobili in colore grigio metallizzato con top in Corian® sp. 40 mm (art. TDC-40), lavello in acciaio inox e miscelatore ad infrarossi.

## SerieDECO

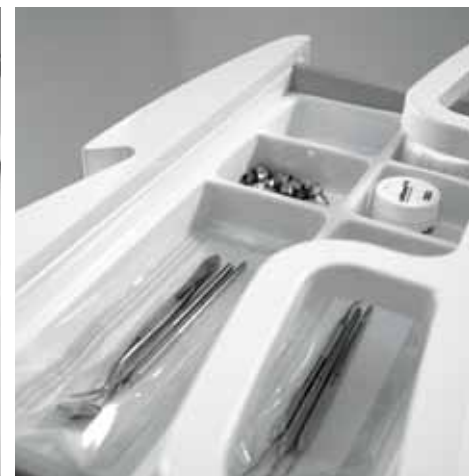

**SerieDECO** offers only the best in components like, for instance, the full extension drawers with soft closure. Photo: metallized grey cabinets with 40 mm thick Corian® top (art. TDC-40), stainless steel sink, infra-red mixer.

**SerieDECO** offre les meilleurs composants comme par exemple des tiroirs à sortie totale pourvus d'une fermeture amortie. Sur la photo : meubles de couleur grise métallisée avec plan de travail en Corian® ép. 40 mm (art. TDC-40), évier en acier inox et mitigeur à commande infrarouge.

**SerieDECO** bietet beste Komponenten wie zum Beispiel die Vollauszug-Schubladen mit stoßgedämpfem Schließmechanismus. Foto: Möbel in der Farbe Metallicgrau mit 40 mm Arbeitsplatte aus Corian® (Art. TDC-40), Edelstahlwaschbecken und Infrarot-Mischbatterie.

**SerieDECO** ofrece los mejores componentes como, por ejemplo, los cajones de extracción total con retorno amortiguado. En la foto: muebles de color gris metalizado con encimera de Corian® de 40 mm de esp. (art. TDC-40), fregadero de acero inoxidable y mezclador por infrarrojos.

# LineaD

Its graceful shapes blend harmoniously with the design of the modular assemblies and offer optimum ergonomics in the work environment. Photo: metallized grey cabinets with 12 mm thick glass top (art. TVS-V10), thermoformed sink, infra-red mixer.

Ses formes sinueuses s'harmonisent au design des modules assemblés et permettent une meilleure ergonomie du lieu de travail. Sur la photo: meubles de couleur grise métallisée avec plan de travail en verre ép. 12 mm (art. TVS-V10) et évier thermoformé avec mitigeur à commande infrarouge.

Ihre abgerundeten Formen harmonieren mit dem Design der Module und erlauben eine bessere Ergonomie am Arbeitsplatz. Foto: Möbel in der Farbe Metallicgrau mit 12 mm Arbeitsplatte aus Glas (Art. TVS-V10) und tiefgezogenem Waschbecken mit Infrarot-Mischbatterie.

Sus formas sinuosas se armonizan con el diseño de los módulos ensamblados y permiten una mejor ergonomía dentro del local de trabajo. En la foto: muebles de color gris metalizado con encimera de cristal de 12 mm de esp. (art. TVS-V10) y fregadero termoformado con mezclador por infrarrojos.



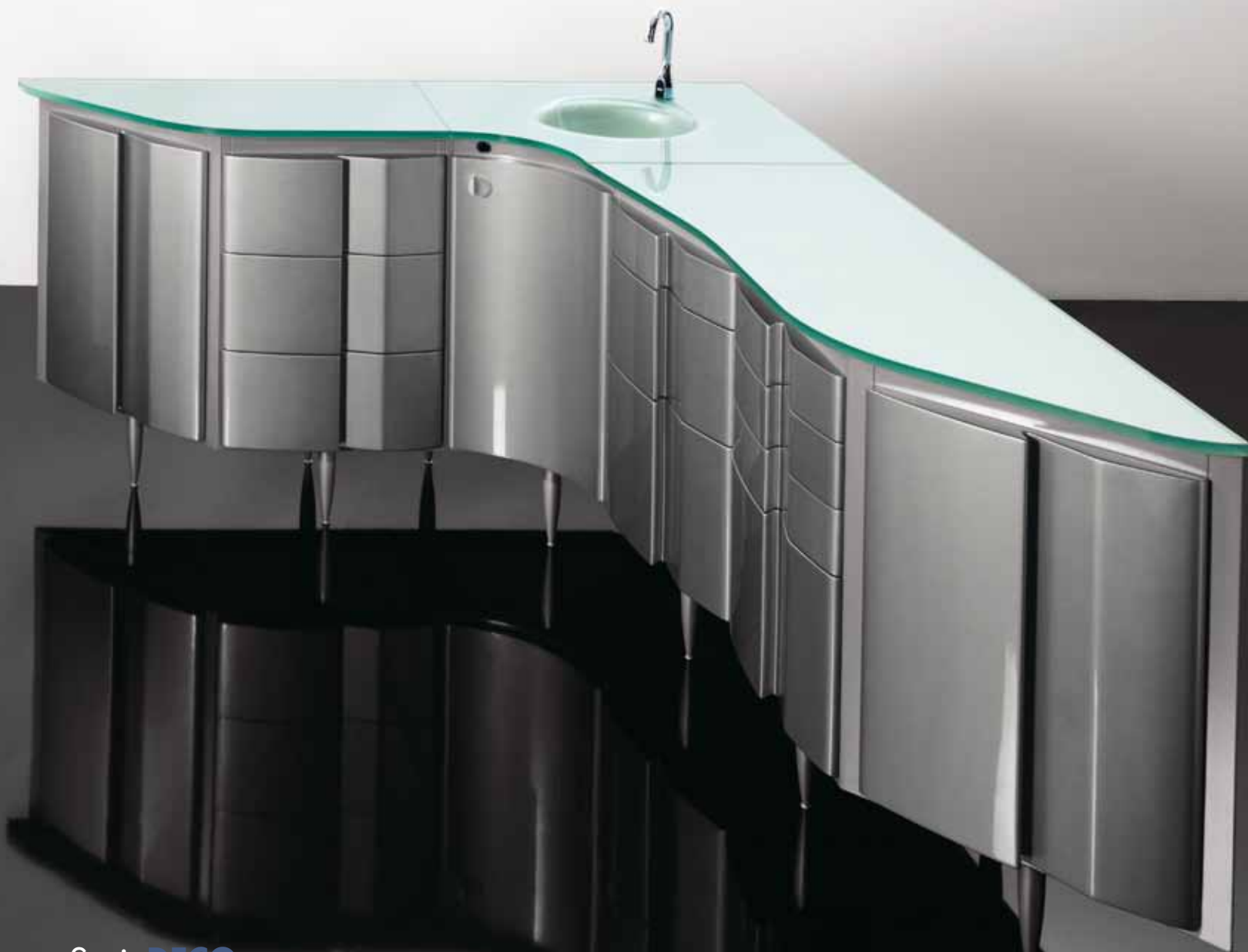

## Serie **DECO**

Le sue forme sinuose si armonizzano con il design dei riuniti e permettono una migliore ergonomia all'interno dell'ambiente di lavoro.  
In foto: mobili in colore grigio metallizzato con top in vetro sp. 12 mm (art. TVS-V10) e lavello termoformato con miscelatore ad infrarossi.

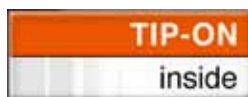

TIP-ON is a mark granted from Julius Blum GmbH

# LineaD



Con l'anca, il ginocchio, la mano o il piede: aprire non è mai stato così facile. Grazie al sistema TIP-ON insieme alla chiusura dolce e silenziosa, offriamo un nuovo comfort di movimento nello studio dentistico.

With the hip, knee, hand or foot: opening has never been so simple. Thanks to the TIP-ON system, combined with the smooth, silent closing, we offer a new comfort of movement in the surgery.

Que ce soit avec la hanche, le genou, la main ou le pied: ouvrir n'a jamais été aussi facile. Grâce au système TIP-ON et à la fermeture silencieuse et en douceur, nous offrons une nouvelle aisance de mouvement dans le cabinet dentaire.



Gleich ob mit der Hüfte, dem Knie, der Hand oder dem Fuß: das Öffnen der Möbelfronten ist noch nie so einfach gewesen. Mit dem TIP-ON Öffnungssystem und dem sanften Schließsystem bieten wir neuen Bewegungskomfort für jede Praxis.

Con la cadera, la rodilla, la mano o el pie: abrir nunca ha sido tan fácil. Gracias al sistema TIP-ON junto con el cierre suave y silencioso, ofrecemos un nuevo confort de movimiento en el gabinete odontológico.



## SerieDECO





SerieDECO è studiata per integrarsi completamente allo studio dentistico, ogni soluzione progettuale trova la sua giusta collocazione. In foto: mobili in colore bianco semilucido, top in Corian sp. 40 mm (art. TDC-40), lavello integrato e miscelatore ad infrarossi.

SerieDECO has been studied to fit into any dental surgery, every design solution just falls perfectly into place. Photo: semi-glossy white cabinets, 40 mm thick Corian top (art. TDC-40), integrated sink, infra-red mixer.

SerieDECO a été étudiée pour s'intégrer parfaitement au cabinet dentaire et chacune des solutions conceptuelles proposées y trouve parfaitement sa place. Sur la photo: meubles de couleur blanche semi-brillante, plan de travail en Corian ép. 40 mm (art. TDC-40), évier intégré et mitigeur à commande infrarouge.

SerieDECO wurde entwickelt, um sich vollständig in die Zahnarztpraxis einzupassen, und jede Projektlösung findet den richtigen Platz. Foto: Möbel in der Farbe Halbglanz-Weiß, 40 mm Arbeitsplatte aus Corian® (Art. TDC-40), integriertes Waschbecken und Infrarot-Mischbatterie.

SerieDECO a sido estudiada para integrarse completamente en la clínica: cada solución de proyecto encuentra su colocación ideal. En la foto: muebles de color blanco semibrillante, encimera de Corian® de 40 mm de esp. (art. TDC-40), fregadero integrado y mezclador por infrarrojos.



Linea **M**



# LineaM



1

Serie **DECO** Linea**M**: il frontale bombato con maniglia in alluminio si fonde in linee morbide e classiche che si armonizzano in ogni ambiente.  
Foto 1: mobili in colore bianco semilucido, top in Corian® sp. 40 mm (art. TDC-40), alzatina e lavello integrati, miscelatore ad infrarossi.  
Foto 2: mobili in colore bianco semilucido, top in Corian® sp. 40 mm (art. TDC-40), lavello in acciaio inox e miscelatore con leva medica.



2

## SerieDECO

**SerieDECO LineaM:** the curved front panel with aluminium handle merges into soft, classic contours that blend harmoniously into any surroundings.

Photo 1: semi-glossy white cabinets, 40 mm thick Corian® top (art. TDC-40), seamless backsplash and sink, infra-red mixer.

Photo 2: semi-glossy white cabinets, 40 mm thick Corian® top (art. TDC-40), stainless steel sink, long lever mixer.

**SerieDECO LineaM:** la façade bombée à poignée en aluminium se fond aux lignes douces et classiques qui caractérisent la ligne tout en s'adaptant parfaitement à tout type de lieu.

Photo 1: meubles de couleur blanche semi-brillante, plan de travail en Corian® ép. 40 mm (art. TDC-40), dossier et évier intégrés, mitigeur à commande infrarouge.

Photo 2: meubles de couleur blanche semi-brillante, plan de travail en Corian® ép. 40 mm (art. TDC-40), évier en acier inox et mitigeur avec levier médical.

**SerieDECO LineaM:** Die gewölbte Front mit Aluminiumgriff löst sich auf in weiche und klassische Linien, die in jedes Ambiente passen.

Foto 1: Möbel in der Farbe Halbglanz-Weiß, 40 mm Arbeitsplatte aus Corian® (Art. TDC-40), Abschlussleiste und Waschbecken integriert, Infrarot-Mischbatterie.

Foto 2: Möbel in der Farbe Halbglanz-Weiß, 40 mm Arbeitsplatte aus Corian® (Art. TDC-40), Edelstahlwaschbecken und medizinische Einhebel-Mischbatterie.

**SerieDECO LineaM:** la parte frontal curvada con tirador de aluminio se funde en líneas suaves y clásicas que se armonizan en cada ambiente.

Foto 1: muebles de color blanco semibrillante, encimera de Corian® de 40 mm de esp. (art. TDC-40), copete y fregadero integrados, mezclador por infrarrojos.

Foto 2: muebles de color blanco semibrillante, encimera de Corian® de 40 mm de esp. (art. TDC-40), fregadero de acero inoxidable y mezclador de palanca.

# Piani / Lavelli / Rubinetti Tops / Sinks / Water-taps



- 01 Art. **TSD-W**: piano Stratificato bianco / white Stratificato top  
Art. **LX1**: lavello inox / st. steel sink  
Art. **GR4**: mixer leva medica / mixer long lever  
Art. **SB8**: dispenser sapone / soap dispenser
- 02 Art. **TSD-G**: piano Stratificato grigio / grey Stratificato top  
Art. **LX1**: lavello inox / st. steel sink  
Art. **GR4**: mixer leva medica / mixer long lever
- 03 Art. **TVS**: piano in vetro / glass top  
Art. **LVT**: lavello termoformato / thermoformed sink  
Art. **MICRO**: mixer leva medica / mixer long lever
- 04 Art. **TDC-40**: piano in CORIAN / CORIAN top  
Art. **LCO**: lavello integrato / integrated sink  
Art. **COMPACTO**: miscelatore a infrarossi / infra-red operated mixer-faucet

01

## Inserti in PST PST inserts

- 01 Art. **DIL + PSA**: portastrumenti / instrument holder
- 02 Art. **DIR**: inserto 4 scomparti / 4 compartments insert
- 03 Art. **DIS**: inserto 6 scomparti / 6 compartments insert
- 04 Art. **DIP**: inserto 9 scomparti / 9 compartments insert
- 05 Art. **DIL**: inserto liscio / plain insert
- 06 Art. **SBSA**: inserto 4 scomparti / 4 compartments insert
- 07 Art. **SBLA**: inserto liscio / plain insert



02



03



04



05



06



07



Alcuni esempi tra le molteplici possibilità compositive. SerieDECO permette soluzioni che ottimizzano lo spazio all'interno del tuo studio. Una vera innovazione rispetto agli arredamenti tradizionali evidenziati con tratto rosso nella pagina accanto.

A few examples of the many possibilities in layout. SerieDECO offers solutions that optimise the space in your surgery. A real innovation compared to the traditional concept of furniture as shown in the next page in red.

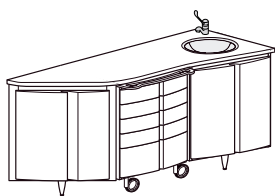

**Art. DD1** W 146 /D 56,5 / H 87

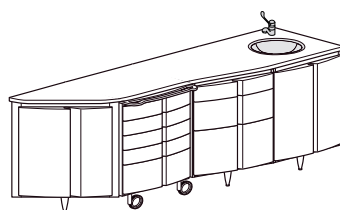

**Art. DD2** W 196 /D 56,5 / H 87

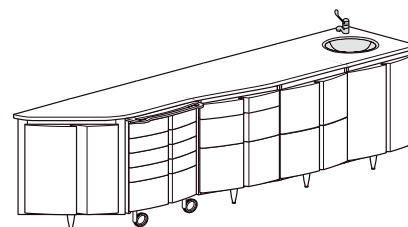

**Art. DD3** W 246 /D 56,5 / H 87

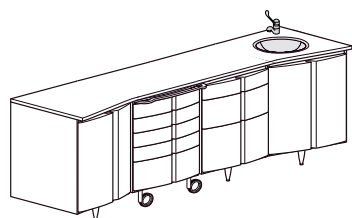

**Art. DD5** W 204 /D 56,5 / H 87

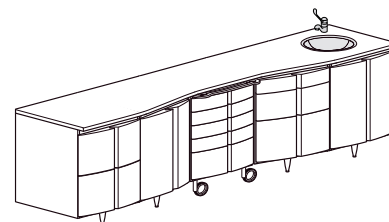

**Art. DD6** W 254 /D 56,5 / H 87

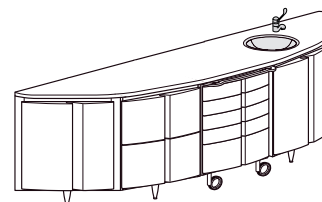

**Art. DD8** W 246 /D 56,5 / H 87

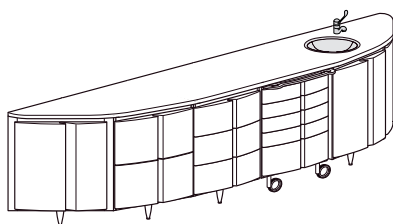

**Art. DD9** W 288 /D 56,5 / H 87

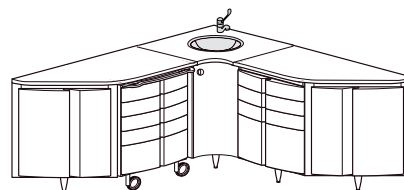

**Art. DD10** W 162-166 /D 46,5 / H 87

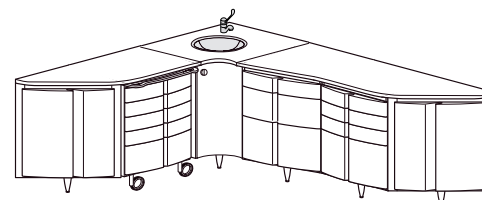

**Art. DD11** W 176+214 /D 56,5 / H 87



Quelques exemples parmi les multiples possibilités de compositions.

SerieDECO apporte des solutions qui permettent d'optimiser l'espace de votre cabinet dentaire. Une véritable innovation par rapport aux ameublements traditionnels signalés ci-dessous par un trait rouge.

Einige Beispiele für die vielfältigen Gestaltungsmöglichkeiten. Die SerieDECO bietet Möglichkeiten, die das Raumangebot in Ihrer Praxis optimieren. Eine echte Innovation gegenüber den traditionellen Einrichtungen, die hier nachfolgend rot eingezeichnet sind.

Le presentamos algunos ejemplos de entre las múltiples posibilidades de composición.

SerieDECO permite soluciones que optimizan el espacio dentro de su clínica. Una auténtica innovación respecto a los muebles tradicionales. Observe los ejemplos resaltados en rojo.

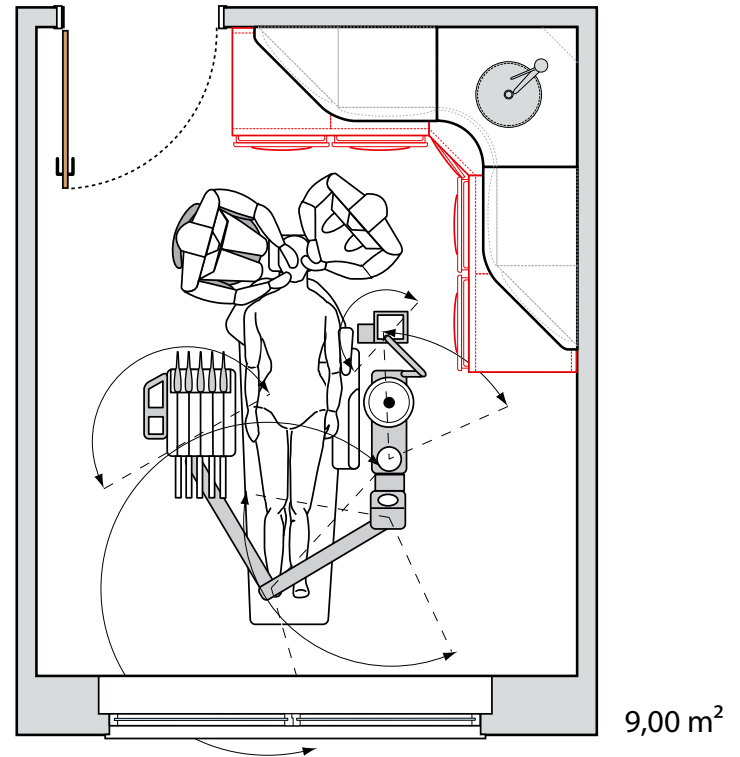
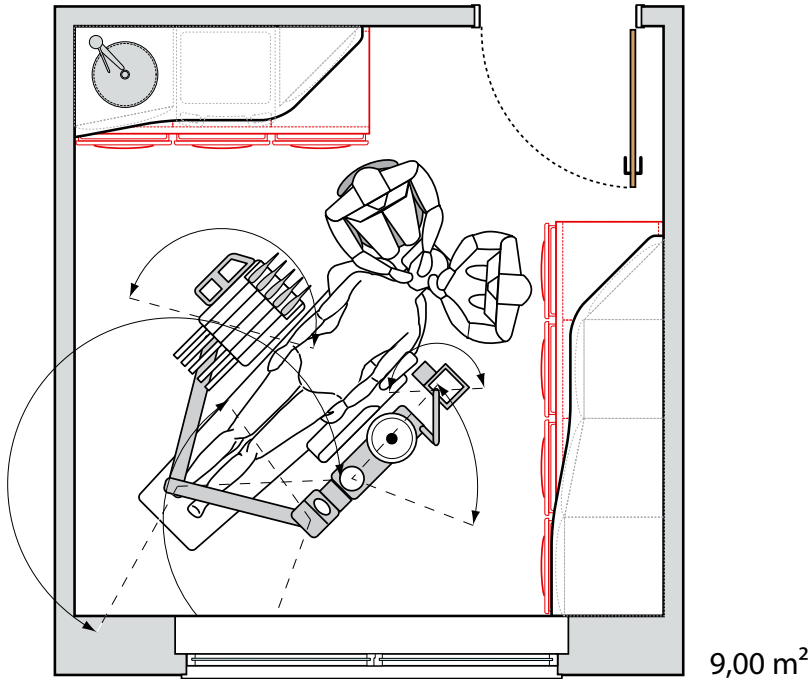

CE



# Colori / Colors / Couleurs / Farbe / Colores

Mobili  
Cabinets  
Meubles  
Möbel  
Muebles

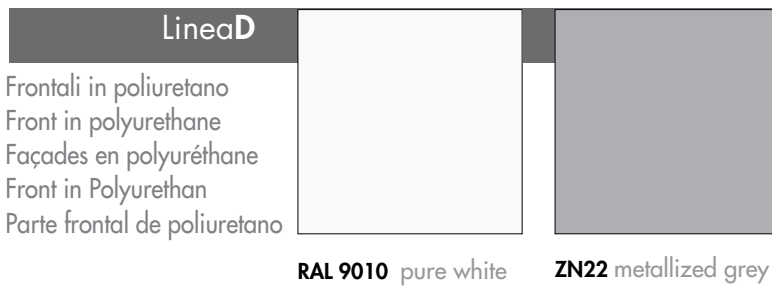
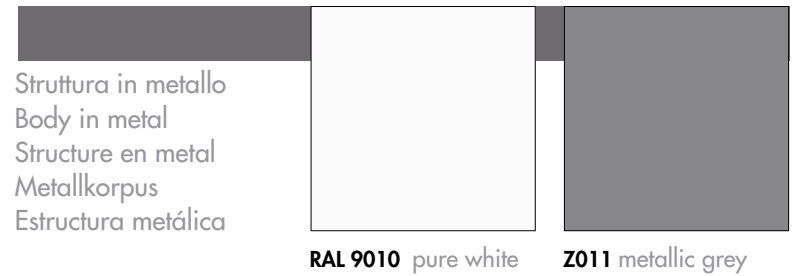

Piani  
Tops  
Plateaux  
Oberflächen  
Encimeras

STRATIFICATO PRINT HPL - 12 mm



TSD-W white

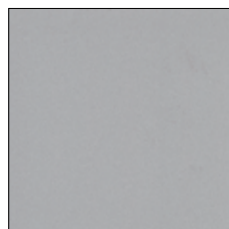

TSD-G grey

CORIAN® - 12 mm



TDC-12 glacier white

CORIAN® - 40 mm



TDC-40 glacier white

VETRO VERNICIATO / PAINTED GLASS / VERRE VERNI / GLAS LACKIERT / CRISTAL PINTADO - 15 mm



TVS V22 sky blue



TVS S011 azure



TVS V10 light green



TVS V12 apple green



TVS M02 met. gold



TVS V26 blue



TVS V11 emerald green

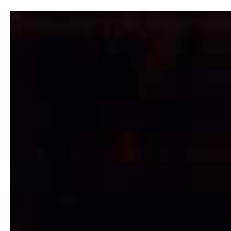

TVS V03 black



TVS V01 white



TVS M01 met. grey



TVS AB09 orange



TVS CU007 red



TVS V51 bordeaux



TVS IR12 violet



TVS V57 pink

*I colori qui riprodotti sono puramente rappresentativi e possono subire variazioni e modifiche anche senza preavviso. Fanno fede solo i campioni reali.  
The reproduced colors are only indicative and are subject to variations and modifications even without prior notice, Only the samples provide accuracy.*

Authorized Dealer:



Via Venezia, 105  
31020 - Tezze di Vazzola  
Treviso - Italia  
Tel. +39 0438 488183  
Fax +39 0438 488187  
info@aries-online.com  
www.aries-online.com

**aries**  
STAR MEDICAL SYSTEMS

Aries si riserva il diritto di modificare i modelli rappresentati. - Aries reserves the right to change the models described. - La société Aries se réserve le droit de modifier les modèles représentés. - Aries behält sich das Recht zur Abänderung der vorgestellten Modelle vor.